



**RY170PWA**



## IMPORTANT!

It is essential that you read the instructions in this manual before assembling, operating, and maintaining the product.

Subject to technical modification.

Safety, performance, and dependability have been given top priority in the design of your electric high pressure cleaner.

## INTENDED USE

The electric high pressure cleaner is intended only for outdoor use. For safety reasons, the product must be adequately controlled by a two-handed operation.

The product is designed for home or domestic use. It is intended to clean machines, vehicles, buildings, floors, tools, facades, terraces, floors, and concrete walkways by removal of stubborn dirt using clean water with or without cleaning detergent.

The product should be used in well-illuminated conditions.

**⚠ WARNING!** The product is intended for use only in premises that have a service current capacity of  $\geq 100$  A per phase.

Do not use the product for any other purpose.

**⚠ WARNING!** The product is designed for use with a neutral cleaning agent supplied or recommended by the manufacturer. The use of other cleaning agents or chemicals may adversely affect the safety of the product.

## GENERAL SAFETY WARNINGS

**⚠ WARNING! Read all safety warnings and all instructions.** Failure to follow the warnings and instructions may result in electric shock, fire, and/or serious injury.

- The product is not intended for use by children or persons with reduced physical, sensory, or mental capabilities, or lack of experience and knowledge. Children should be adequately supervised to ensure they do not play with the product.
- Wear complete personal protective equipment when operating the product, such as boots, safety gloves, safety helmets with visor, and hearing protection. Use high-impact visors only with liquid splash protection.

**⚠ WARNING!** Do not use the product when people are within range, unless they wear protective clothing.

- To reduce the risk of injury, keep children and visitors away. All visitors should wear safety glasses and be kept at a safe distance from the work area.
- Ensure that the safety devices are in good working condition. Make sure that all safety devices are operating properly before each use.
- Do not use the product if the power cord or other important parts, such as safety devices, high-pressure hoses, or trigger gun, are damaged.
- Exercise caution when opening the trigger. Hold the trigger handle firmly with two hands to avoid injury when the trigger handle kicks back.

**⚠ WARNING!** During use of high pressure cleaners, aerosols may be formed. Inhalation of aerosols can be hazardous to health. Depending on the application, shielded nozzles can be used for high pressure cleaning, which will reduce the emission of hydrous aerosols. However, not all applications allow the use of such a device. If shielded nozzles are not applicable for the protection against aerosols, a respiratory mask of class FFP 2 or equivalent may be needed, depending on the cleaning environment.

- Always stop the product when you leave it unattended.
- High pressure jet is dangerous if misused. Do not direct the jet to people, live electrical equipment, or the product itself.
- To avoid a risk of explosion, do not spray flammable liquids.
- Do not direct the jet against yourself or others to clean clothes or footwear.
- Do not use the product to clean electronic devices, clothes, or footwear.
- High pressure hoses, fittings, and couplings are important for the safety of the product. Use only hoses, fittings, and couplings that are recommended by the manufacturer.
- Injuries may be caused, or aggravated, by prolonged use of a tool. When using any tool for prolonged periods, ensure you take regular breaks.

**⚠ CAUTION** The product must not be used on a drinking water supply without a backflow preventer that corresponds to EN 12729 Type BA. Water that has flowed through a backflow preventer is considered non-drinkable. Always observe the regulations of your local water utility company when connecting the product to a water supply line.

### ELECTRICAL SAFETY WARNINGS

- The plug must match the outlet. Never modify the plug in any way. Unmodified plugs and matching outlets reduce the risk of electric shock.
- Do not use the product if the power cord or other important parts, such as safety devices, are damaged.
- Check the power cord and the extension cord for damage before each use. If the power cord or the extension cord is damaged, it must be replaced by the manufacturer, its service agent, or similarly qualified persons in order to avoid a hazard.
- Before every use, examine the supply cord for damage. If there are signs of damage, it must be replaced by a qualified person at an authorised service centre to avoid a hazard.
- Keep the power cord away from heat, oil, and sharp edges.
- Never touch the mains plug and the socket with wet hands.
- Inadequate extension cords can be dangerous. If an extension cord is used, it shall be suitable for outdoor use, and the connection has to be kept dry and off the ground. Use a cord wheel to keep the socket at least 60 mm above the ground.
- The electric supply connection shall be made by a qualified electrician and comply with IEC 60364-1. It is recommended that the electric supply to this product should include either a residual current device that will interrupt the supply if the leakage current to earth exceeds 30 mA for 30 ms or a device that will prove the earth circuit.

### ADDITIONAL SAFETY WARNINGS

- Some regions have regulations that restrict the use of the product in some operations. Check with your local authority for advice.
- Before each use, check the product for damage. A damaged high-pressure hose must be replaced. Ensure that all connections, such as high-pressure hose

and nozzle, are secure. Unwind the hose properly so they may not get twisted or kinked.

- Do not allow children or untrained individuals to use the product.
- Before starting any cleaning operation, close doors and windows. Clear the area to be cleaned of debris, toys, outdoor furniture, or other objects that could create a hazard.
- Never pick up or carry the product while the motor is running.
- Do not use the product in temperatures below 0°C.
- Do not use acids, alkalines, solvents, flammable material, bleaches, or industrial grade solutions in the product. These products can cause physical injuries to the operator and irreversible damage to the product.
- Always operate the product on a level surface.

**⚠ WARNING!** High pressure jet can be dangerous if subjected to misuse. The jet must not be directed to people, animals, electrical devices, or the product itself.

- Hold the trigger handle securely with both hands. Expect the trigger handle to move when the trigger is pulled due to reaction forces. Failure to do so could cause loss of control and injury to yourself and others.
- Make sure that the air in the hose and pump is released before you turn on the product. To remove the air in the hose and pump, connect the water supply to the pump using a garden hose, connect the trigger handle to the pump using the high-pressure hose, disengage the trigger handle lock, and press the trigger until there is a steady flow.
- Exercise caution to avoid slipping or falling.
- Keep firm footing and balance. Do not overreach. Overreaching can result in loss of balance.
- Use only accessories that are recommended by the manufacturer. The use of improper accessories may cause injury.
- Never leave the product running unattended. Turn off the product. Do not leave the product if it has not come to a complete stop.
- Be familiar with the controls. Know how to stop the product and bleed the pressure quickly.

- Stay alert and exercise control. Watch what you are doing and use common sense.
- Do not use the product while tired, ill, or under the influence of drugs, alcohol, or medication. A moment of inattention while operating the product may result in serious personal injury.
- Do not use the product if the switch does not turn it on and off. Any product that cannot be controlled with a switch is dangerous and must be repaired.
- Keep a minimum distance of 30 cm when cleaning vehicles. The high pressure jet may damage or burst vehicle tires and/or tire valves.
- Use a garden hose with a maximum length of 15 m and minimum diameter of 18 mm (3/4 in.).
- Before each use, ensure that the accessory is securely attached to the trigger gun.

### OVERLOAD PROTECTION

The product has an overload protection device that is activated when overheating or when a current spike occurs, automatically shutting down the power within the product. To resume operation, disconnect the product from the power supply, wait for about 15 minutes, and reconnect the product to the power supply.

### TRANSPORTATION AND STORAGE

**⚠ CAUTION!** Mind the weight of the product when selecting the storage location and during transportation to prevent accidents or injuries.

- Stop the product, disconnect from the power supply, and allow the product to cool down. Disconnect the product from the water supply before storing or transporting. Never place the product in any position other than upright.
- Clean all foreign materials from the product. Store it in a cool, dry, and well-ventilated place that is inaccessible to children. Keep the product away from corrosive agents such as garden chemicals and de-icing salts. Do not store the product outdoors.
- Remove water from all hoses and the pump, and empty the detergent tank before storing the product.
- For transportation in a vehicle, secure the product against movement or falling to

prevent injury to persons or damage to the product.

- Store the product indoors only. Storing the product in an area with temperature below 0°C will damage the product.

### MAINTENANCE

- Use only original manufacturer's replacement parts, accessories, and attachments. Failure to do so can cause possible injury, can contribute to poor performance, and may void your warranty.
- Servicing requires extreme care and knowledge and should be performed only by a qualified service technician. Have the product serviced by an authorised service centre only.
- Turn off the product, disconnect from the power supply and water supply, and allow the product to cool down:
  - before servicing
  - before clearing a blockage
  - before checking, cleaning, or working on the product
- You may make adjustments or repairs described in this manual. For other repairs, contact an authorised service centre.
- Regularly inspect and maintain the high pressure cleaner for safe operation. RYOBI recommends inspecting the product every 6 months.
- Check all nuts, bolts, and screws at frequent intervals for proper tightness to ensure that the product is in safe working condition. Any part that is damaged should be properly repaired or replaced by an authorised service centre.

### KNOW YOUR PRODUCT

See page 7.

1. Carry handle
2. High pressure hose
3. Hose reel
4. Reel handle
5. Rolling support
6. Adapter clip
7. Internal high pressure hose
8. Detergent tank cap
9. Detergent tank
10. Lance hook
11. Power cord holder
12. Trigger gun holder
13. On/off switch
14. Handle screws

15. Water inlet filter
16. Nozzle cleaning tool
17. Water inlet port
18. Wheel
19. Detergent function switch
20. Nozzle holder
21. Trigger handle lock
22. Trigger
23. Hose lock button
24. Turbo lance
25. Vario lance
26. QC adapter
27. Operator's manual
28. Garden hose
29. Ryobi detergent
30. Garden hose connector

**NOTE:** If using a detergent, refer to the Material Safety Data Sheet of the detergent.

### SAFETY DEVICES

- On/Off switch
  - The on/off switch prevents unintentional operation of the product.
- Trigger handle lock
  - The trigger handle lock locks the trigger and prevents unintentional opening of the high-pressure jet.
- Overflow valve with pressure switch
  - The overflow valve prevents the permissible working pressure from being exceeded. If the lever on the trigger gun is released, the pressure switch turns off the pump and the high-pressure jet stops. If the lever is pulled, the pump turns on again.
- Overload protection
  - A thermal sensor protects the product from overloading. The product will automatically shut the power down while overheating.

### SYMBOLS ON THE PRODUCT



Read and understand all instructions before operating the product. Follow all warnings and safety instructions.



Wear eye and hearing protection.



Power



The product is not suitable for connection to the drinking water mains without backflow preventer.



Never point the spray wand to people, animals, the body of the product, power supply, or any electric appliances.



Maximum pressure



European Conformity Mark



British Conformity Mark



EurAsian Conformity Mark



Ukraine Conformity Mark



Guaranteed sound power level



Waste electrical products should not be disposed of with household waste. Recycle where facilities exist. Check with your local authority or retailer for recycling advice.

### SYMBOLS IN THIS MANUAL



Wear non-slip, heavy-duty, protective gloves when handling.



Parts or accessories sold separately



Connect to power outlet.



Disconnect from power outlet.



Note



Warning

# RY170PWA

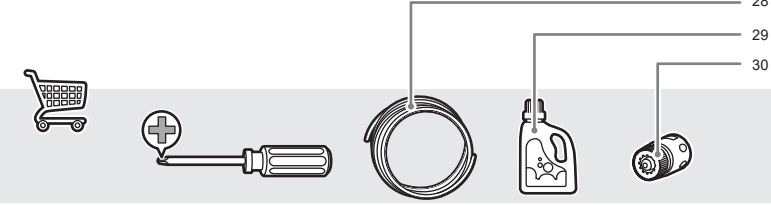
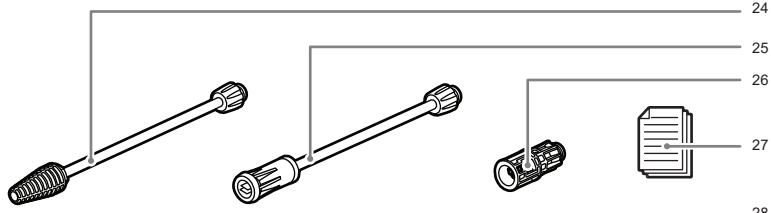
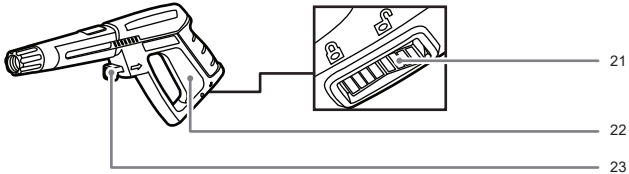
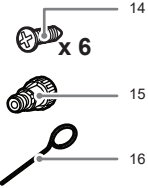
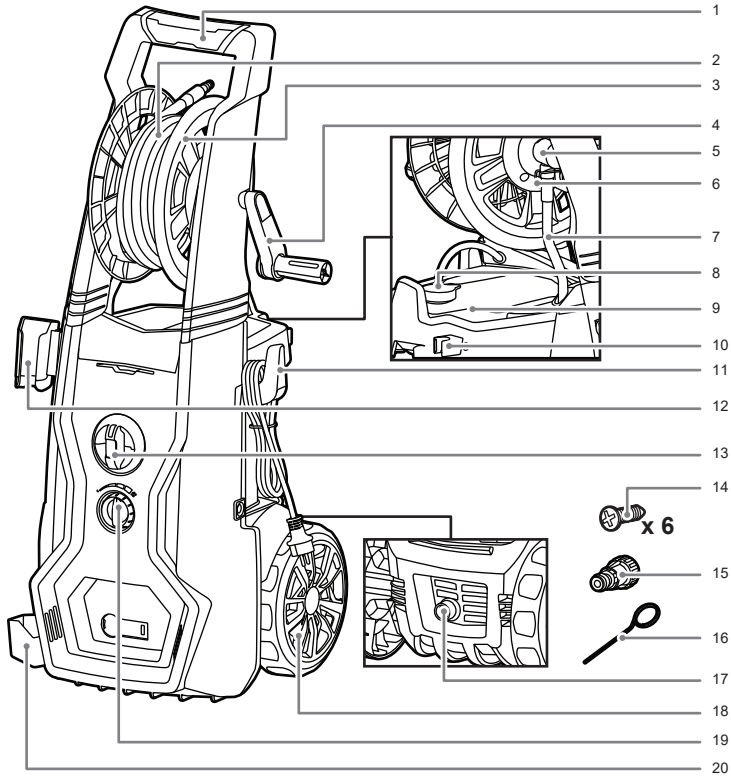



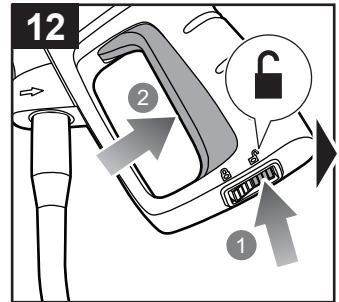
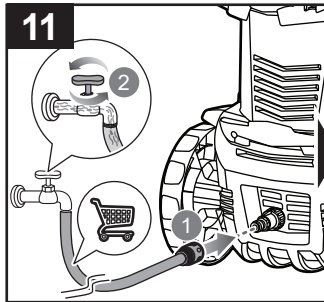
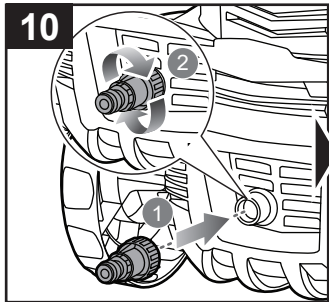
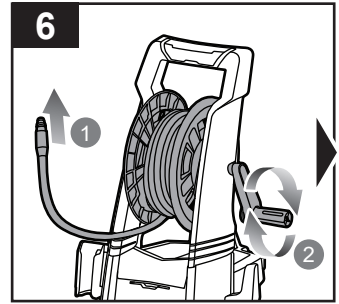
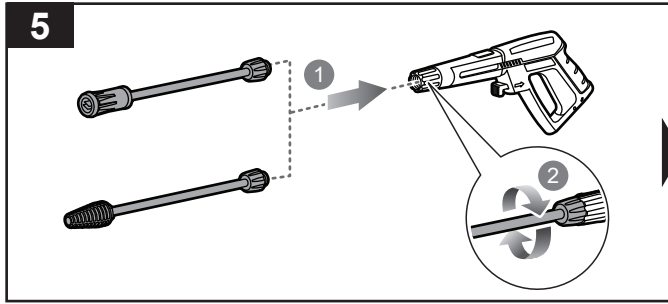
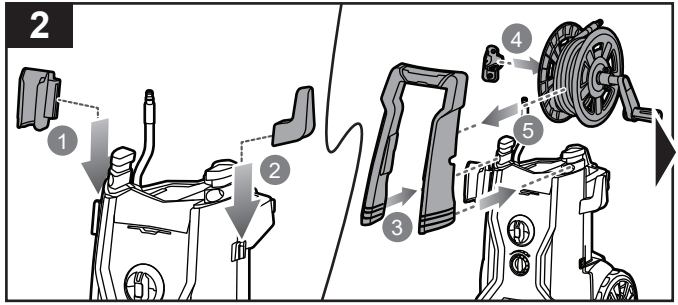
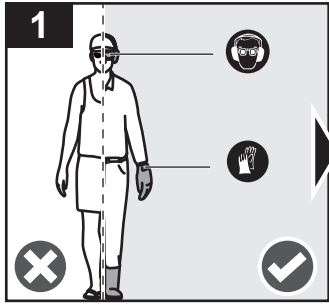



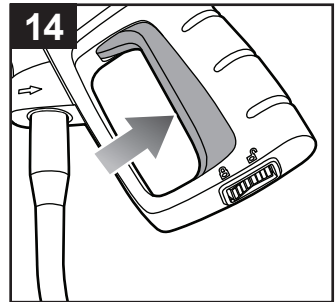
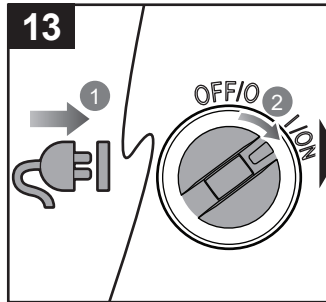
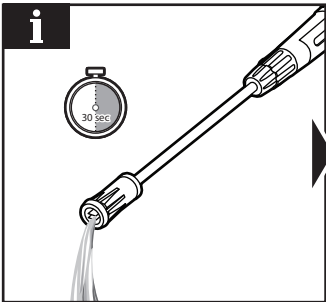
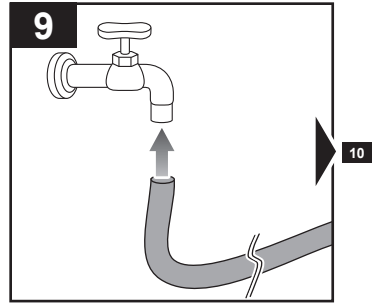
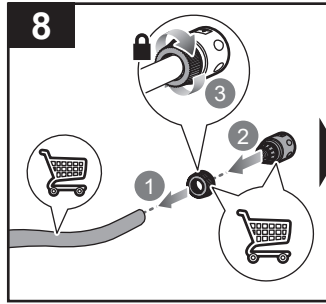
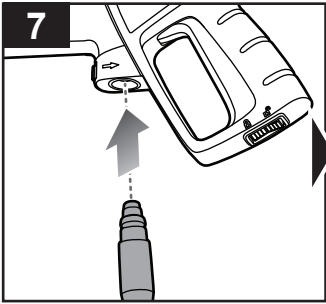
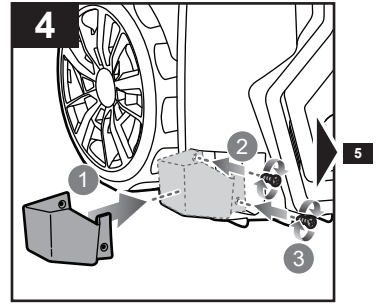
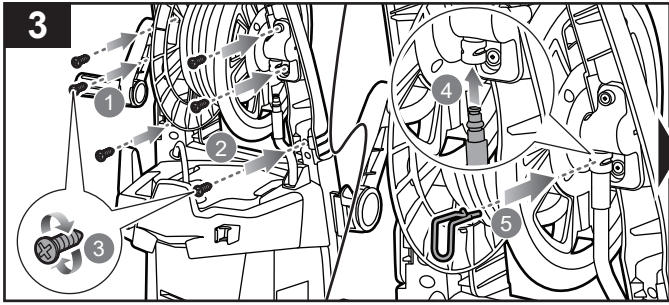

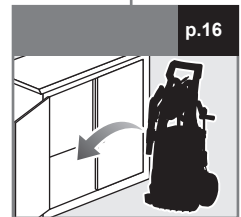
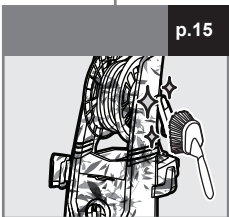
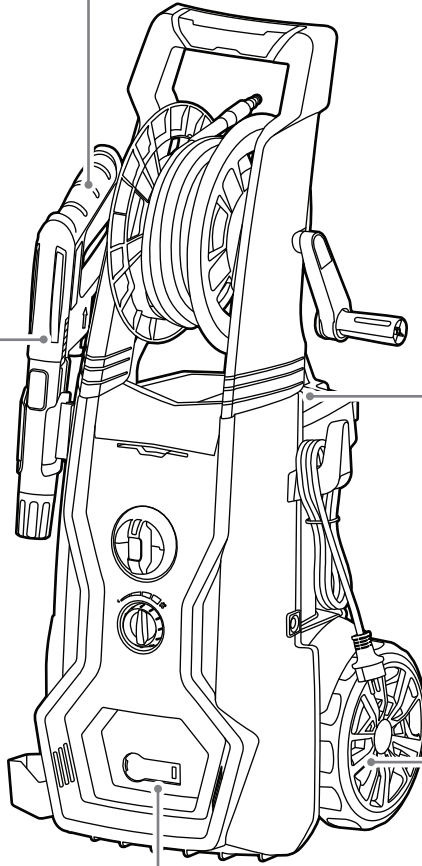
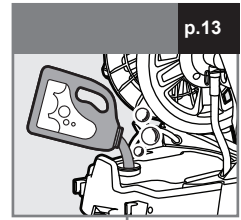
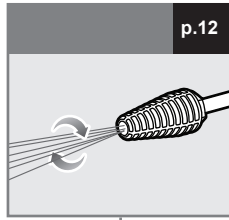
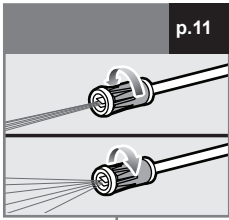

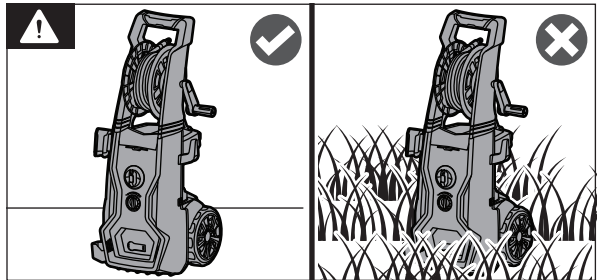
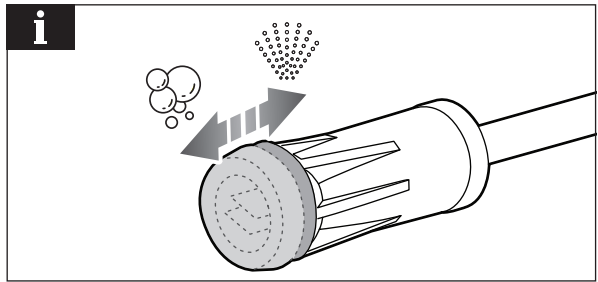
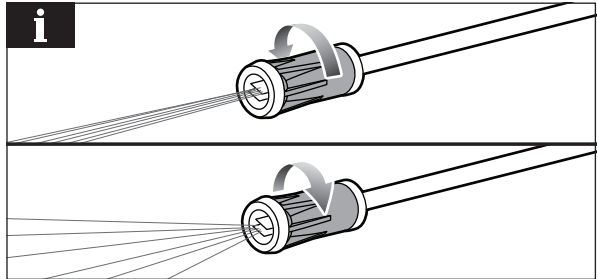
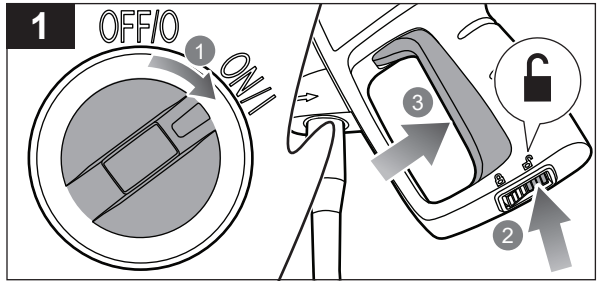
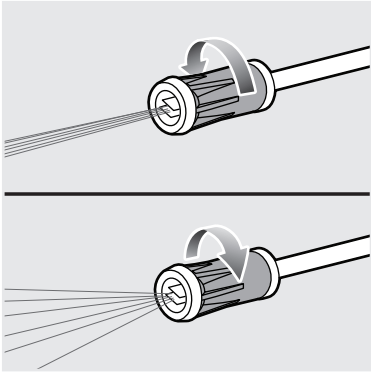

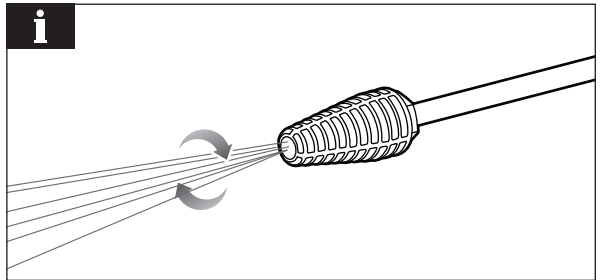
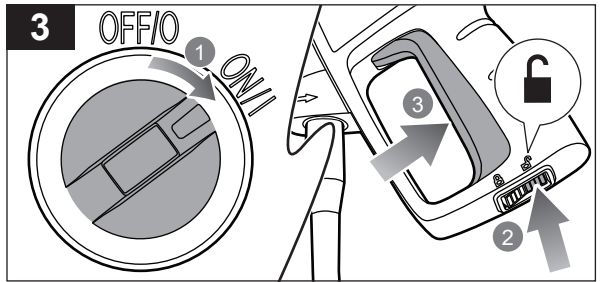
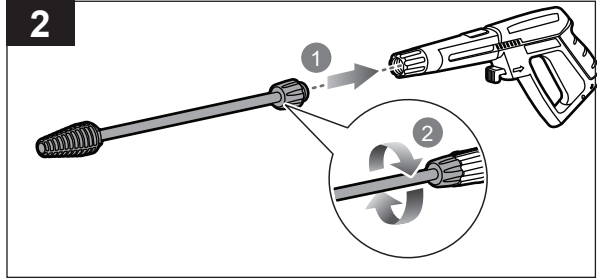
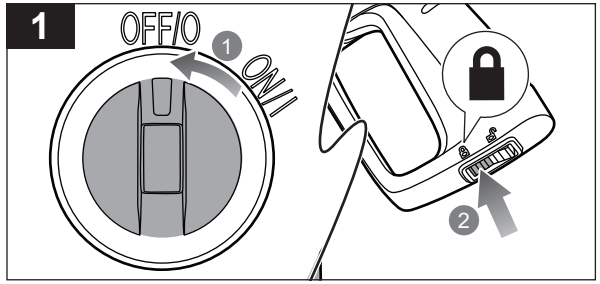
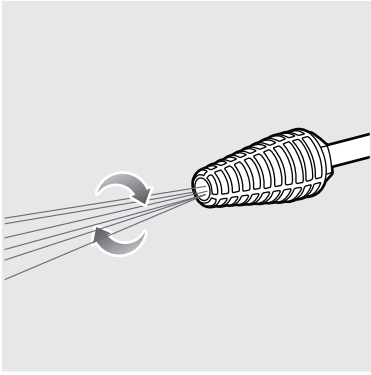

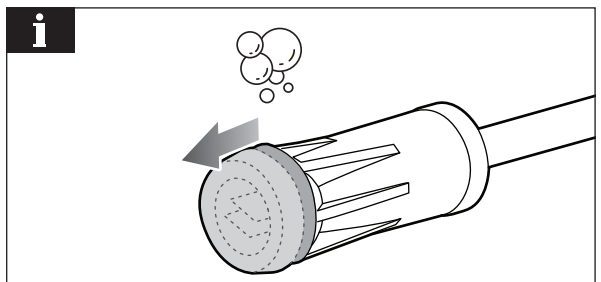
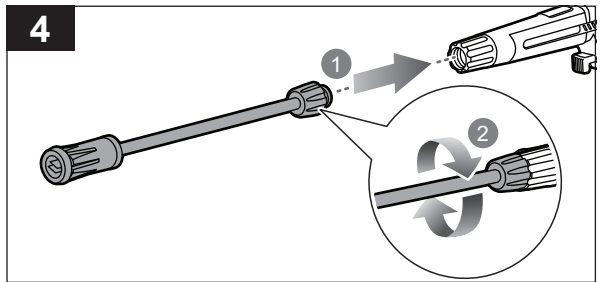
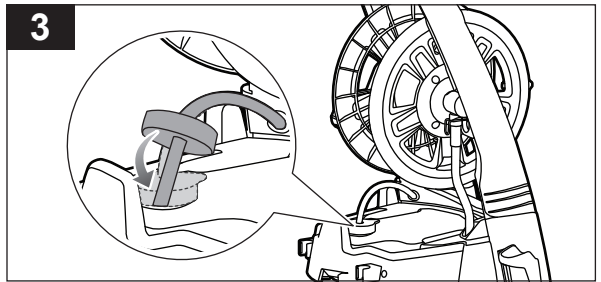
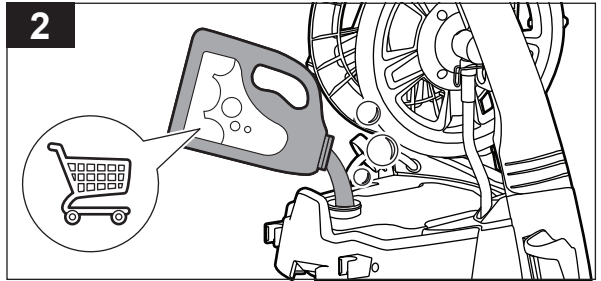
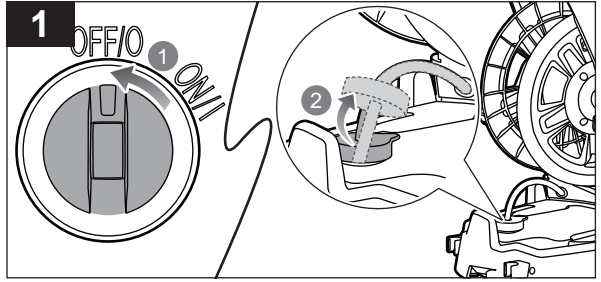
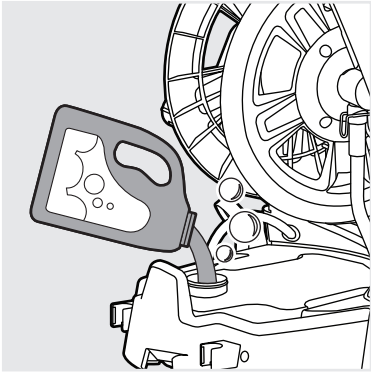

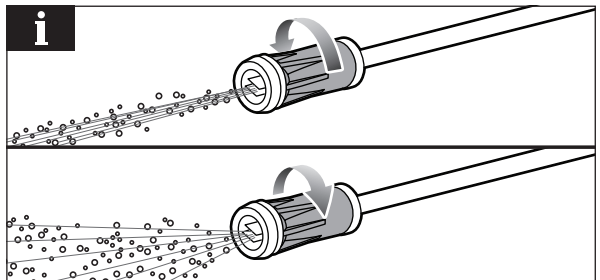
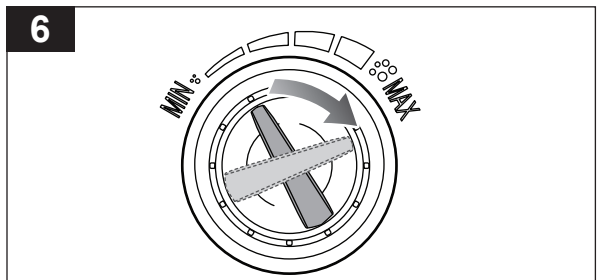
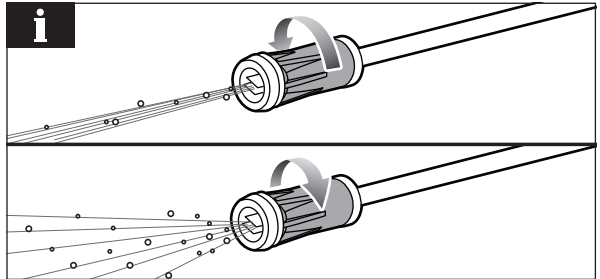
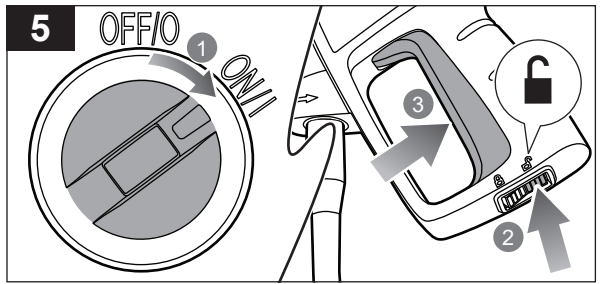

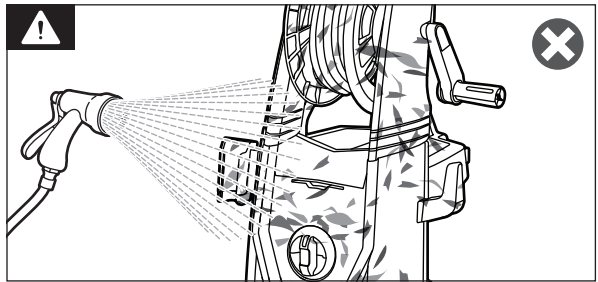
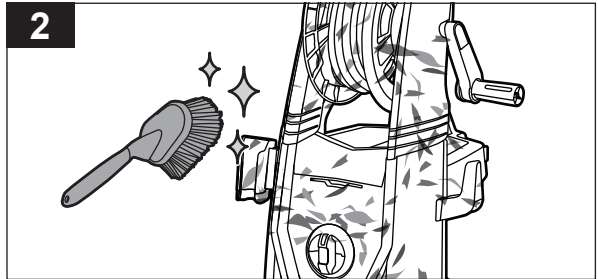
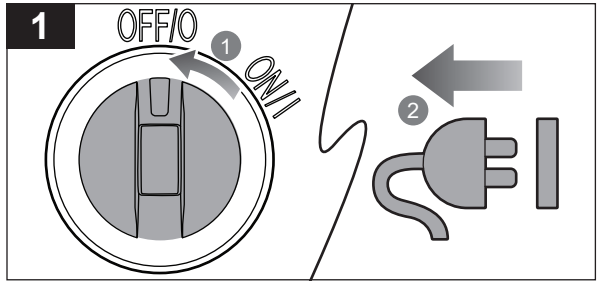
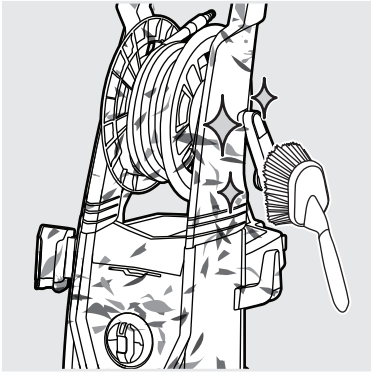



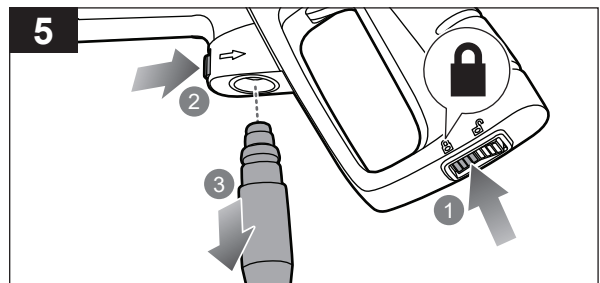
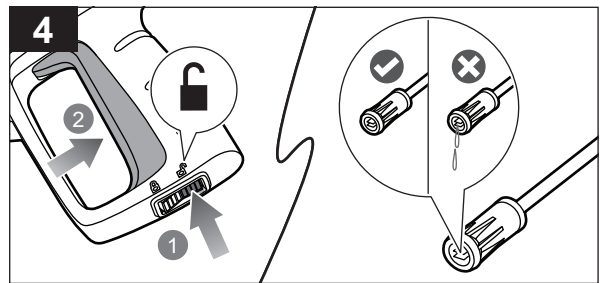
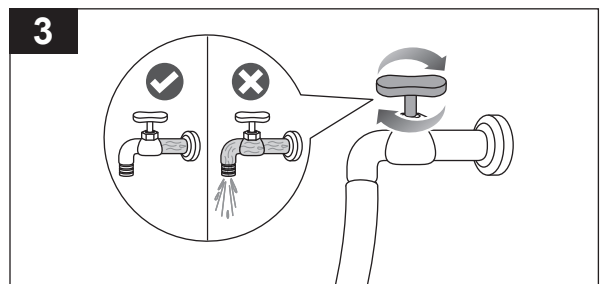
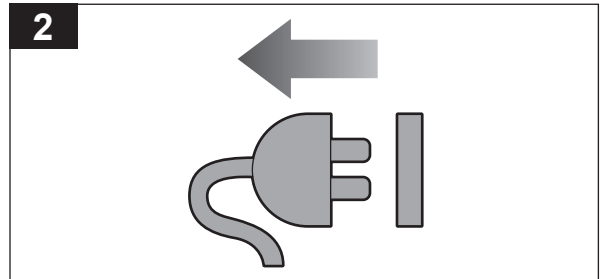
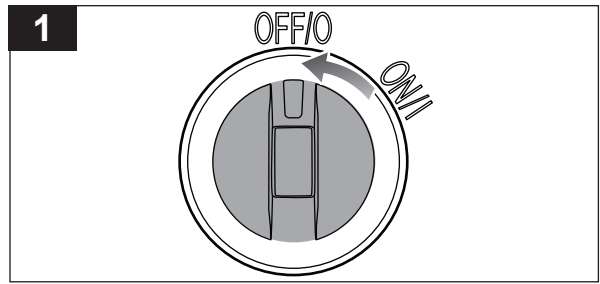

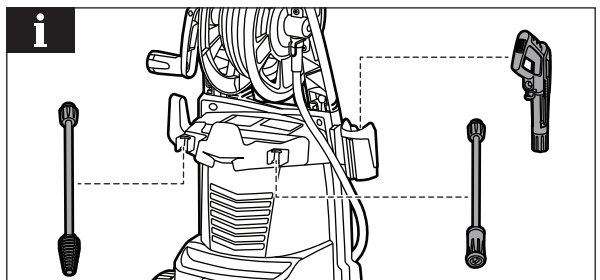
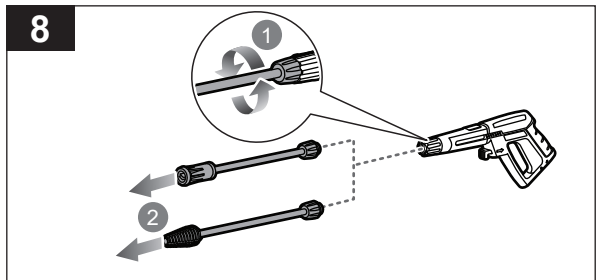
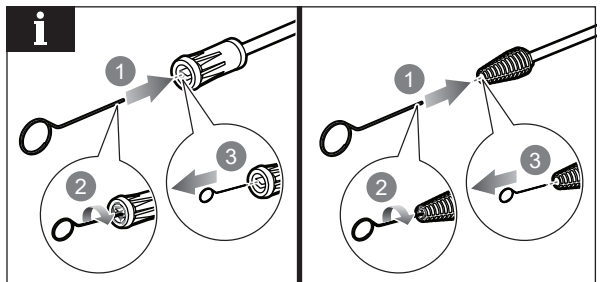
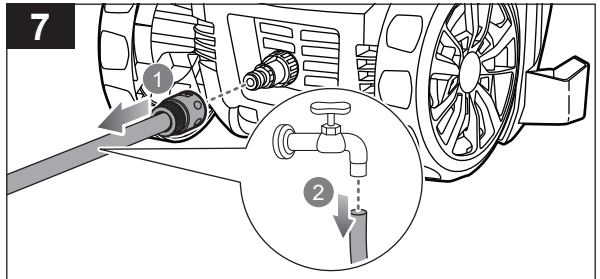
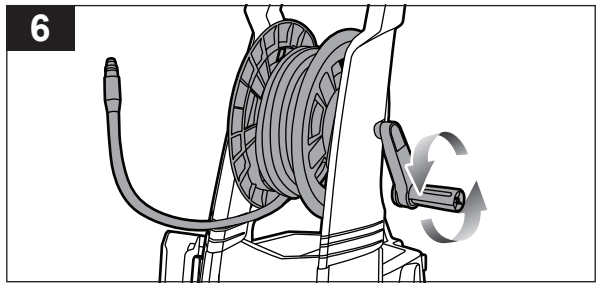

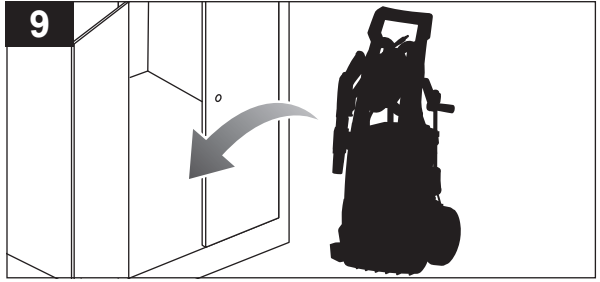

## TROUBLESHOOTING

Problem	Possible causes	Solution
Fluctuating pressure	Pump sucking air	Check that hoses and connections are air tight.
	Dirty, worn-out, or stuck valves	Bring the product to an authorised service centre for service or repair.
	Worn-out pump seals	Bring the product to an authorised service centre for service or repair.
Product stops	Thermal sensor activated	Leave the cleaner for 15 minutes to cool down.
	Partially blocked nozzle	Clean the nozzle.
Product pulsating	Air in inlet hose/pump	Allow the product to run with open trigger until regular working pressure resumes.
	Inadequate supply of mains water	Check that the water supply corresponds to the specifications required (see model tag). Avoid using long, thin hoses.
	Partially blocked nozzle	Clean the nozzle.
	Blocked water filter	Clean the filter.
	Kinked hose	Straighten out hose.
Product starts, but no water comes out	Frozen pump/hoses or accessory	Wait for pump/hoses or accessory to thaw.
	No water supply	Connect the water inlet port to a water supply.
	Blocked water filter	Clean the filter.
	Blocked nozzle	Clean the nozzle.
No detergent	Nozzle adjusted to high pressure	Adjust to low pressure.

## PRODUCT SPECIFICATIONS

Electric high pressure cleaner

Model	RY170PWA
Rated voltage	230-240 V a.c.
Frequency	50 Hz
Power	2200 W
Maximum pressure	17 MPa (170 bar)
Rated pressure	13 MPa (130 bar)
Degree of protection	IPX5
Rated flow	7.0 L/min
Maximum flow	7.8 L/min
Maximum inlet water pressure	1.2 MPa (12 bar)
Detergent tank	1.3 L
Power cord length	5 m
Sound pressure level ( $L_{PA}$ ) (in accordance with EN 60335-2-79)	72.5 dB(A)
Uncertainty	3 dB
Sound power level ( $L_{WA}$ ) (in accordance with EN 60335-2-79)	86.2 dB(A)
Uncertainty	3 dB
Vibration value (in accordance with EN 60335-2-79)	< 2.5 m/s <sup>2</sup>
Uncertainty	1.5 m/s <sup>2</sup>
Weight	24 kg
Maximum garden hose length	15 m
Minimum garden hose diameter	18 mm (3/4 in.)

## ACCESSORIES

Syphoning kit	RAC769
Surface cleaner	RAC772
Fixed/Multipurpose brush	RAC774
Foam detergent bottle	RAC775
Adaptor *	RAC780
Angled turbo lance	RAC782
Water inlet filter	RAC784
Rotary brush	RAC785
Pipe cleaning hose	RAC786
O-rings	RAC788
Adaptor (previous range accessory to current product)	RAC790

Adaptor (current range accessory to previous product)

RAC791

\*Compatible adaptor for KÄRCHER pressure cleaner accessories.

**NOTE:** Check the specification of the accessory part if it matches the specifications of the RYOBI high pressure cleaner.

**⚠ WARNING!** The declared vibration total values and the declared noise emission values given in this instruction manual have been measured in accordance with a standardised test and may be used to compare one tool with another. They may be used for a preliminary assessment of exposure.

The declared vibration and noise emission values represent the main applications of the tool. However, if the tool is used for different applications, used with different accessories, or poorly maintained, the vibration and noise emission may differ. These conditions may significantly increase the exposure levels over the total working period.

An estimation of the level of exposure to vibration and noise should take into account the times when the tool is turned off or when it is running idle. These conditions may significantly reduce the exposure level over the total working period.

Identify additional safety measures to protect the operator from the effects of vibration and noise, such as maintaining the tool and the accessories, keeping the hands warm (in case of vibration), and organising work patterns.

## RYOBI WARRANTY APPLICATION CONDITIONS

In addition to any statutory rights resulting from the purchase, this product is covered by a warranty as stated below.

- The warranty period is 24 months for consumers and commences on the date the product was purchased. This date has to be documented by an invoice or other proof of purchase. The product is designed and dedicated to consumer and private use only. So there is no warranty provided in case of professional or commercial use. This warranty applies only on new products.
- There is a possibility to extend for a part of the range of power tools (AC/DC) the warranty period over the period described above using the registration on the [www.ryobitools.eu](http://www.ryobitools.eu) website. The eligibility of products for extended warranty is clearly displayed in stores and / or on packaging and is contained within the product documentation. The end user is required to register his/her newly-acquired products online within 30 days from the date of purchase. The end user may register for the extended warranty in his/her country of residence if listed on the online registration form where this option is valid. Furthermore, end users must give their consent to the storage of their personal data that is required to be entered online. They must also accept the terms and conditions. The registration confirmation receipt, which is sent out by e-mail, and the original invoice showing the date of purchase will serve as proof of the extended warranty.
- The warranty covers all defects of the product during the warranty period due to faults in workmanship or material at the purchase date. The warranty is limited to repair and/or replacement and does not include any other obligations including but not limited to incidental or consequential damages. The warranty is not valid if the product has been misused, used contrary to the instruction manual, or has been incorrectly connected to a power supply. This warranty does not apply to:
  - any damage to the product that is the result of improper or lack of maintenance
  - any product that has been altered or modified
  - any product where original identification (trade mark, serial number) markings have been defaced, altered or removed
  - any damage caused by non-observance of the instruction manual
  - any product not displaying the CE approval mark on the rating plate
  - any product that has been attempted to be repaired by a non-authorised warranty service centre or without prior authorisation by Techtronic Industries
  - any product connected to an improper power supply (amps, voltage, frequency)
  - any product used with inappropriate fuel mixture (fuel, oil, Ratio of oil / fuel mixture)
  - any damage caused by external influences (water, chemical, physical, shocks) or foreign substances
  - normal wear and tear spare parts
  - inappropriate use, overloading of the tool
  - use of non-approved accessories or parts
  - Accessories provided with the tool or purchased separately including but not limited to blades, saw chains, cutting lines etc.
  - Any periodic adjustments to or maintenance cleaning of carburetors
  - Components (parts and accessories) subject to natural wear and tear, including but not limited to bump knobs, drive belts, clutch, blades of hedge trimmers or lawn mowers, harness, cable throttle, carbon brushes, power cord, tines, felt washers, hitch pins, blower fans, blower and vacuum tubes, vacuum bag and straps, guide bars, saw chains, hoses, connector fittings, spray nozzles, wheels, spray wands, inner reels, outer spools, cutting lines, spark plugs, air filters, gas filters, mulching blades, etc.
- For servicing, the product must be sent or presented to a RYOBI authorised service station listed for each country in the following list of service station addresses. In some countries your local RYOBI dealer undertakes to send the product to the RYOBI service organisation. When sending a product to a RYOBI service station, the product should be safely packed without any dangerous contents such as petrol, marked with sender's address and accompanied by a short description of the fault.
- A repair / replacement under this warranty is free of charge. It does not constitute an extension or a new start of the warranty period. Exchanged parts or products become our property. In some countries delivery charges or postage will have to be paid by the sender. Your statutory rights arising from the purchase of the product remain unaffected.
- This warranty is valid in the European Community, Switzerland, Iceland, Norway, Liechtenstein, Turkey, Russia, and the United Kingdom. Outside these areas, please contact your authorised RYOBI dealer to determine if another warranty applies.

## AUTHORISED SERVICE CENTRE

Any request or issue with the product can be addressed to your local authorized service centres (visit [www.ryobitools.eu](http://www.ryobitools.eu)) or directly to: Techtronic Industries GmbH, Max Eyth Straße 10, 71364 Winnenden, Germany. Please state the serial number and product type printed on the label.

## EC DECLARATION OF CONFORMITY

Manufacturer: Techtronic Industries GmbH  
Max-Eyth-Straße 10, 71364 Winnenden, Germany

*We declare as the manufacturer under our sole responsibility that the product mentioned below*

Electric high pressure cleaner  
Brand: RYOBI  
Model number: RY170PWA  
Serial number range: 47588501000000 - 47588501999999

*fulfills all the relevant provisions of the following European Directives, European Regulations and harmonized standards:*

2006/42/EC, 2014/30/EU, 2011/65/EU,  
EN 60335-1:2012+A2:2019, EN 60335-2-79:2012,  
EN 55014-1:2017+A11:2020, EN 55014-2:2015,  
EN IEC 63000:2018, EN IEC 61000-3-2:2019,  
EN 62233:2008, EN 61000-3-11:2013+A1:2019

Measured sound power level: 86.2 dB(A)  
Guaranteed sound power level: 90 dB(A)  
Conformity assessment method to Annex V Directive 2000/14/EC amended by 2005/88/EC.

Sven Eschrich  
VP of Engineering - TTI Outdoor Power Division  
Winnenden, Jan. 15, 2021

Authorised to compile the technical file:  
Alexander Krug, Managing Director  
Techtronic Industries GmbH  
Max-Eyth-Straße 10, 71364 Winnenden, Germany

## GB-DECLARATION OF CONFORMITY

Manufacturer: Techtronic Industries GmbH  
Max-Eyth-Straße 10, 71364 Winnenden, Germany

*We declare as the manufacturer under our sole responsibility that the product mentioned below*

Electric high pressure cleaner  
Brand: RYOBI  
Model number: RY170PWA  
Serial number range: 47588601000000 - 47588601999999

*fulfills all the relevant provisions of the following Regulations: S.I. 2008/1597 (as amended), S.I. 2016/1091 (as amended), S.I. 2012/3032 (as amended) and that the following designated standards have been used:*

BS EN 60335-1:2012+A2:2019,  
BS EN 60335-2-79:2012, BS EN 55014-1:2017+A11: 2020,  
BS EN 55014-2:2015, BS EN IEC 61000-3-2:2019,  
BS EN 61000-3-11:2013+A1:2019, BS EN 62233:2008,  
BS EN IEC 63000:2018

Measured sound power level: 86.2 dB(A)  
Guaranteed sound power level: 90 dB(A)  
Conformity assessment method to S.I. 2001/1701 Schedule 8 (as amended)

Sven Eschrich  
VP of Engineering - TTI Outdoor Power Division  
Winnenden, Jan. 15, 2021

Authorised to compile the technical file:  
Techtronic Industries (UK) Ltd  
Fieldhouse Lane  
Marlow Bucks SL7 1HZ  
UK

*RYOBI is a trade mark of Ryobi Limited, and is used under license.  
KÄRCHER is a registered trade mark of Alfred Kärcher GmbH & Co. KG.*







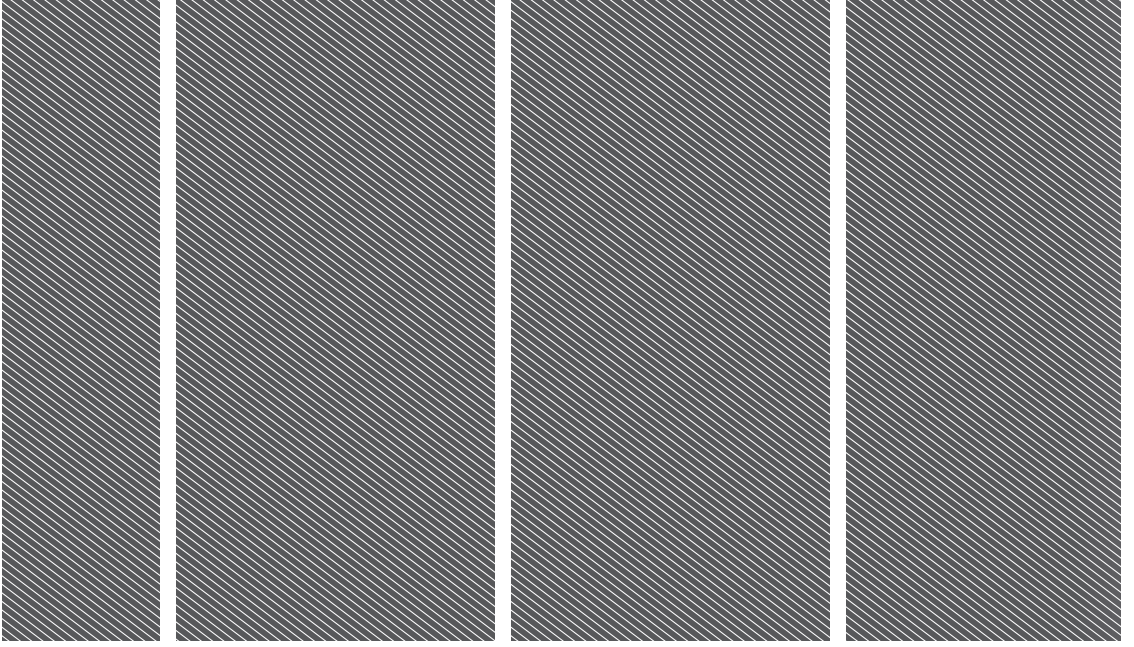

**Techtronic Industries GmbH**  
Max-Eyth-Straße 10,  
71364 Winnenden, Germany

**Techtronic Industries (UK) Ltd**  
Fieldhouse Lane  
Marlow Bucks SL7 1HZ  
UK

099903074001-01

